

A  
Major Project  
On  
**RADIOSONDE PAYLOAD FOR WEATHER MONITORING  
SYSTEM**

(Submitted in partial fulfillment of the requirements for the award of Degree)

**BACHELOR OF TECHNOLOGY**

In  
**COMPUTER SCIENCE AND ENGINEERING**

By  
CH. LAKSHMI SRAVYA (187R1A0567)  
S. THARUN (187R1A05B3)  
P. RITHVIK (187R1A0581)

Under the Guidance of

**J. NARASIMHARAO**

(Associate Professor)



**DEPARTMENT OF COMPUTER SCIENCE AND ENGINEERING**

**CMR TECHNICAL CAMPUS**

**UGC AUTONOMOUS**

(Accredited by NAAC, NBA, Permanently Affiliated to JNTUH, Approved by AICTE, New  
Delhi) Recognized Under Section 2(f) & 12(B) of the UGCAct.1956, Kandlakoya (V),  
Medchal Road, Hyderabad-501401.

**2018-2022**

**DEPARTMENT OF COMPUTER SCIENCE AND ENGINEERING**



**CERTIFICATE**

This is to certify that the project entitled “**RADIOSONDE PAYLOAD FOR WEATHER MONITORING SYSTEM**” being submitted by **CH. LAKSHMI SRAVYA (187R1A0567), S. THARUN (187R1A05B3), P. RITHVIK (187R1A0581)** in partial fulfillment of the requirements for the award of the degree of B.Tech in Computer Science and Engineering to the Jawaharlal Nehru Technological University Hyderabad, is a record of bonafide work carried out by them under our guidance and supervision during the year 2021-22.

It is certified that they have completed the project satisfactorily. The results embodied in this thesis have not been submitted to any other University or Institute for the award of any degree or diploma.

**J. Narasimharao**  
(Associate Professor)  
INTERNAL GUIDE

**Dr. A. RAJI REDDY**  
DIRECTOR

**Dr. K. Srujan Raju**  
HOD

**EXTERNAL EXAMINER**

Submitted for viva voice Examination held on \_\_\_\_\_

## ACKNOWLEDGEMENT

Apart from the efforts of us, the success of any project depends largely on the encouragement and guidelines of many others. We take this opportunity to express our gratitude to the people who have been instrumental in the successful completion of this project.

We take this opportunity to express my profound gratitude and deep regard to my guide **J. Narasimharao**, Associate Professor for his exemplary guidance, monitoring and constant encouragement throughout the project work. The blessing, help and guidance given by him shall carry us a long way in the journey of life on which we are about to embark.

We also take this opportunity to express a deep sense of gratitude to the Project Review Committee (PRC) **Mr. A. Uday Kiran, Mr. J. Narasimharao, Dr. T. S. Mastan Rao, Mrs. G. Latha, Mr. A. Kiran Kumar**, for their cordial support, valuable information and guidance, which helped us in completing this task through various stages.

We are also thankful to **Dr. K. Srujan Raju**, Head, Department of Computer Science and Engineering for providing encouragement and support for completing this project successfully.

We are obliged to **Dr. A. Raji Reddy**, Director for being cooperative throughout the course of this project. We also express my sincere gratitude to Sri. **Ch. Gopal Reddy**, Chairman for providing excellent infrastructure and a nice atmosphere throughout the course of this project.

The guidance and support received from all the members of **CMR Technical Campus** who contributed to the completion of the project. We are grateful for their constant support and help.

Finally, We would like to take this opportunity to thank our family for their constant encouragement, without which this assignment would not be completed. We sincerely acknowledge and thank all those who gave support directly and indirectly in the completion of this project.

<b>CH. LAKSHMI SRAVYA</b>	<b>(187R1A0567)</b>
<b>S. THARUN</b>	<b>(187R1A05B3)</b>
<b>P. RITHVIK</b>	<b>(187R1A0581)</b>

## **ABSTRACT**

This project aims to design a reliable embedded system that will be used for measuring, temperature, pressure, and humidity in the atmosphere for up-to-date weather monitoring. Weather is monitored with the help of payload equipment in which temperature, pressure, and humidity sensors. These measured values are then transmitted to the ground receiver for forecast and analysis which would display information timely. Radiosonde data is a valuable resource in the detection of climate change in the upper atmosphere. These measured values are then transmitted to the ground station for forecast and analysis. Radio frequency signals are used for communication between ground station and the floating station (space station) respectively along with GSM module to send location on mobile in order to increase the reliability of the project. Radiosonde data is a valuable resource in the detection of climate change in the upper atmosphere. Long time series of stratospheric temperature data, carefully screened and corrected to remove errors, are available for this purpose. Normal reporting practice usually ascribes a fixed time and position to all data reported in the ascent.

## LIST OF FIGURES

<b>FIGURE NO</b>	<b>FIGURE NAME</b>	<b>PAGE NO</b>
Figure 2.5.1.1	Arduino nano	6
Figure 2.5.1.2	BMP280 Sensor	7
Figure 2.5.1.3	DHT11 Sensor	7
Figure 2.5.1.4	NRF24 Sensor	8
Figure 2.5.1.5	LDR Module	8
Figure 2.5.1.6	SD Card	9
Figure 2.5.1.7	HC-05 Sensor	9
Figure 2.5.1.8	RTC Clock Module	10
Figure 3.1	Project Architecture for Radiosonde Payload for Weather Monitoring System	11
Figure 3.2	Use case diagram for Radiosonde Payload for Weather Monitoring System	12
Figure 3.3	Class Diagram for Radiosonde Payload for Weather Monitoring System	13
Figure 3.4	Sequence Diagram for Radiosonde Payload for Weather Monitoring System	14
Figure 3.5	Activity Diagram for Radiosonde Payload for Weather Monitoring System	15
Figure 3.6	Dataflow Diagram for Radiosonde Payload for Weather Monitoring System	16

## LIST OF SCREENSHOTS

<b>SCREENSHOT NO</b>	<b>SCREENSHOT NAME</b>	<b>PAGE NO</b>
Screenshot 5.1.1	Transmitter	22
Screenshot 5.1.2	Receiver	22
Screenshot 5.2.1	Display Values for Pressure and Temperature on LCD.	23
Screenshot 5.2.2	Display Values for Altitude and Air-Quality on LCD.	23
Screenshot 5.2.3	Display value of Battery Level on LCD.	24
Screenshot 5.2.4	Display Values for Humidity and Daylight on LCD.	24
Screenshot 5.3	Application view of Sensors Values and Serial Monitor.	25
Screenshot 5.4	SD Card Results	26

## LIST OF TABLES

<b>TABLE NO</b>	<b>TABLE NAME</b>	<b>PAGE NO</b>
Table 2.5.1	Hardware Requirements	6
Table 6.1	Values taken from different test cases	28

# TABLE OF CONTENTS

<b>ABSTRACT</b>	i
<b>LIST OF FIGURES</b>	ii
<b>LIST OF SCREENSHOTS</b>	iii
<b>LIST OF TABLES</b>	iv
<b>1.INTRODUCTION</b>	1
1.1    PROJECT SCOPE	1
1.2    PROJECT PURPOSE	1
1.3    PROJECT FEATURES	1
<b>2.SYSTEM ANALYSIS</b>	2
2.1    PROBLEM DEFINITION	2
2.2    EXISTING SYSTEM	2
2.2.1 LIMITATIONS OF THE EXISTING SYSTEM	3
2.3    PROPOSED SYSTEM	3
2.3.1ADVANTAGES OF PROPOSED SYSTEM	3
2.4    FEASIBILITY STUDY	4
2.4.1    ECONOMIC FEASIBILITY	4
2.4.2    TECHNICAL FEASIBILITY	5
2.4.3    BEHAVIORAL FEASIBILITY	5
2.5    HARDWARE & SOFTWARE REQUIREMENTS	5
2.5.1    HARDWARE REQUIREMENTS	5-10
2.5.2    SOFTWARE REQUIREMENTS	10
<b>3.ARCHITECTURE</b>	11
3.1    PROJECT ARCHITECTURE	11
3.2    DESCRIPTION	11
3.3    USE CASE DIAGRAM	12
3.4    CLASS DIAGRAM	13
3.5    SEQUENCE DIAGRAM	14
3.6    ACTIVITY DIAGRAM	15
3.7    DATA FLOW DIAGRAM	16
<b>4.IMPLEMENTATION</b>	17
4.1    SAMPLE CODE	17



<b>5.SCREENSHOTS</b>	22
<b>6.TESTING</b>	27
6.1 INTRODUCTION TO TESTING	27
6.2 TYPES OF TESTING	27
6.2.1 UNIT TESTING	27
6.2.2 INTEGRATION TESTING	27
6.2.3 FUNCTIONAL TESTING	27
6.3 TEST CASES	28
6.3.1 WORKING OF PAYLOAD	28
<b>7. CONCLUSION &amp; FUTURE SCOPE</b>	29
7.1 PROJECT CONCLUSION	29
7.2 FUTURE SCOPE	29
<b>8. REFERENCES</b>	30
8.1 REFERENCES	30
8.2 GITHUB LINK	30

# **1. INTRODUCTION**

# **1. INTRODUCTION**

## **1.1 PROJECT SCOPE**

This project is titled "Radiosonde Payload for Weather Monitoring System". This device helps users to achieve accurate data on the weather temperature and air pressure surrounding it. The project is a research stage effort to construct a working efficient and affordable payload device that is capable of capturing accurate weather conditions. Getting up to date weather statistics for a specific industrial sector is a hassle that needs a high budget weather monitoring system in a grid.

## **1.2 PROJECT PURPOSE**

This project has been developed to achieve a working application that has the ability to read and monitor weather conditions more effectively. The existing weather detection process requires a lot of capital investment including setting up the monitoring device and detecting the trajectory of payload etc. We have put forth our soft skills and technical inputs to device a system which gives better and accurate monitoring results.

## **1.3 PROJECT FEATURES**

There are many features in our project that specifically enhance the performance and effectiveness of the model. The sensors that are placed in the model are effective and task focused instruments that take perfect readings of the air quality, weather conditions, wind movement's, temperatures and humidity. Our model consists of an emergency backup data storage which stores all the data in the module in case of an issue in relaying data in real time to the ground station.

## **2. SYSTEM ANALYSIS**

## **2. SYSTEM ANALYSIS**

### **SYSTEM ANALYSIS**

System Analysis is the important phase in the system development process. The System is studied to the minute details and analyzed. In analysis, a detailed study of these operations performed by the system and their relationships within and outside the system is done. A key question considered here is, “what must be done to solve the problem?” The system is viewed as a whole and the inputs to the system are identified. Once analysis is completed the analyst has a firm understanding of what is to be done.

### **2.1 PROBLEM DEFINITION**

A general statement of this project Radiosonde payload for weather monitoring system can be formulated as the ability of the model to measure the atmosphere weather conditions like temperature, air and pressure. Providing accuracy in measurements with simple yet powerful low cost devices to measure the atmospheric weather conditions.

### **2.2 EXISTING SYSTEM**

At present, the Indian meteorological department measures the practical weather by using hydrogen balloons. In order to measure the practical weather, they have to send hydrogen filled balloons every day at 0.00 and 12.00 UTC. The radiosonde contains sensors capable of making direct real time measurements of air temperature, humidity and pressure with height. A meteorological balloon, carrying instruments and transmitting equipment is released, untethered, rises until it bursts, and falls back using a parachute. The RGR is lifted with weather balloons similar to traditional radiosondes to a tether string and the style is landed and localized.

### **2.2.1 LIMITATIONS OF EXISTING SYSTEM**

Following are the limitations of the existing system:

- The devices used in the making are not cost effective and simple.
- There is no assurance of the device landing in the same place of its launching.
- More manual work would be required as part of the existing system.

### **2.3 PROPOSED SYSTEM**

We propose a device in which it is used to monitor and record atmospheric weather conditions like temperature, air quality and pressure. This can be implemented with sensors communicating with one another connected to an arduino chip which is coded to collect information from all the sensors depicting various atmospheric parameters. The collected information is transmitted to a receiving device which is responsible to display the information from time to time. The payload with the balloon can be placed ranging from 50 mts to 1 km from the receiver for the model to work effectively. The collected information in the receiver can be viewed in our smartphones via bluetooth and can also be stored on the cloud for future uses and to continuously monitor the weather conditions at any place, time and locations.

#### **2.3.1 ADVANTAGES OF THE PROPOSED SYSTEM**

The following are the advantages of the proposed system:

- Simple and reliable data measurement in real time.
- The problem of the device landing at a place different from its launching area is overcome in the proposed system
- Less manual work to implement the model in real time.
- Effective and timely data storage of the information in the cloud.

- Cost effective and simpler devices for weather monitoring
- Easy access to the information on smartphones through bluetooth.

## **2.4 FEASIBILITY STUDY**

The feasibility of the project is analyzed in this phase and the business proposal is put forth with a very general plan for the project and some cost estimates. During system analysis, the feasibility study of the proposed system is to be carried out. This is to ensure that the proposed system is not a burden to the company. Three key considerations involved in the feasibility analysis:

- Economic Feasibility
- Technical Feasibility
- Social Feasibility

### **2.4.1 ECONOMIC FEASIBILITY**

The developing system must be justified by cost and benefit. Criteria to ensure that effort is concentrated on a project, which will give best, return at the earliest. One of the factors, which affect the development of a new system, is the cost it would require. The following are some of the important financial questions asked during the preliminary investigation:

- The costs conduct a full system investigation.
- The cost of the hardware and software.
- The benefits are in the form of reduced costs or fewer costly errors.

Since the system is developed as part of project work, there is no manual cost to spend for the proposed system. Also, all the resources are already available, which gives an indication that the system is economically possible for development.

## **2.4.2 TECHNICAL FEASIBILITY**

This study is carried out to check the technical feasibility, that is, the technical requirements of the system. Any system developed must not have a high demand on the available technical resources. The developed system must have a modest requirement, as only minimal or null changes are required for implementing this system.

## **2.4.3 BEHAVIORAL FEASIBILITY**

This includes the following questions:

- Is there sufficient support for the users?
- Will the proposed system cause harm?

The project would be beneficial because it satisfies the objectives when developed and installed. All behavioral aspects are considered carefully and conclude that the project is behaviorally feasible.

## **2.5 HARDWARE & SOFTWARE REQUIREMENTS**

### **2.5.1 HARDWARE REQUIREMENTS:**

Hardware interfaces specify the logical characteristics of each interface between the software product and the hardware components of the system.

The following are some hardware requirements:



MATERIAL	QUANTITY
BMP280	1
DHT11, HC-05	1
NRF24	1
IR SENSOR	2
ARDUINO NANO	1
SD CARD	3
Bluetooth	-
RTC CLOCK MODULE	1

Table 2.5.1 Hardware Requirements

**2.5.1.1 Arduino nano:** Arduino nano is also the microcontroller through which all the connections are made and sensors are connected. Arduino IDE is used to communicate with the sensor's actions and has 14 pins in total and operates at 5volts. In the developed model, three microcontrollers are used for transmitter and receiver connections.

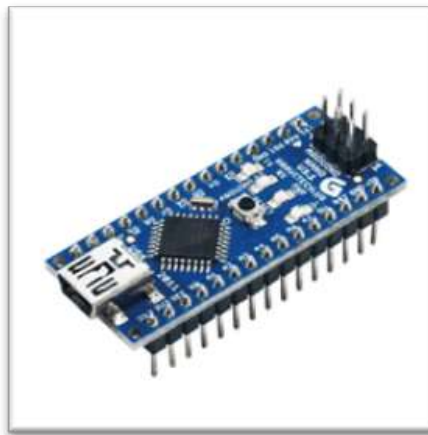

Figure 2.5.1.1 Arduino nano

**2.5.1.2 BMP280:** The real-time temperature and air pressure can be known with a BMP280 sensor. It uses a very low amount of power to operate effectively.

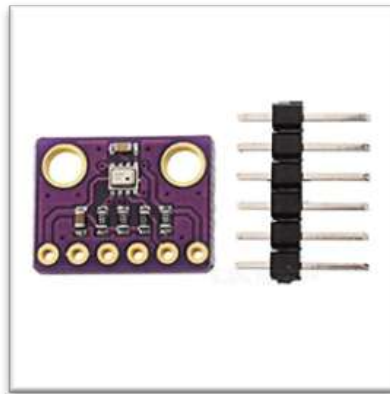

Figure 2.5.1.2 BMP280 Sensor

**2.5.1.3 DHT11:** DHT11 is a temperature and humidity sensor. The sensor has a humidity measurement component and a temperature measurement component. High reliability, fast response, and cost-effectiveness can be seen with this sensor.

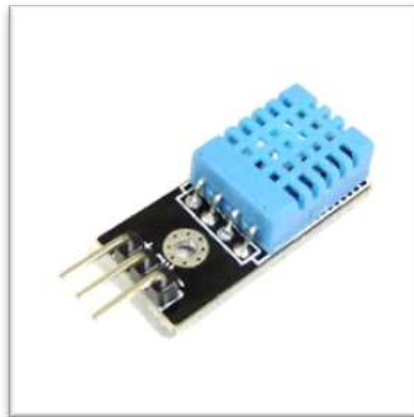

Figure 2.5.1.3 DHT11 Sensor

**2.5.1.4 NRF24:** NRF24 signal is used for wireless communication between all the microcontrollers. Transmission of received data is provided by the RF transmitter, while the data is received by the RF receiver.

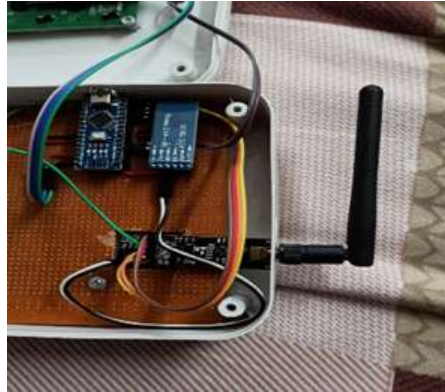

Figure 2.5.1.4 NRF24 Sensor

**2.5.1.5 LDR MODULE:** To indicate the presence of daylight in particular surroundings LDR module is used. Depending upon the presence or absence of light the daylight is measured and displayed.



Figure 2.5.1.5 LDR Module

**2.5.1.6 SD CARD:** The memory card is used to store the information from the sensors that are present in the transmitter module. The SD card when connected to a personal computer the information can be viewed.

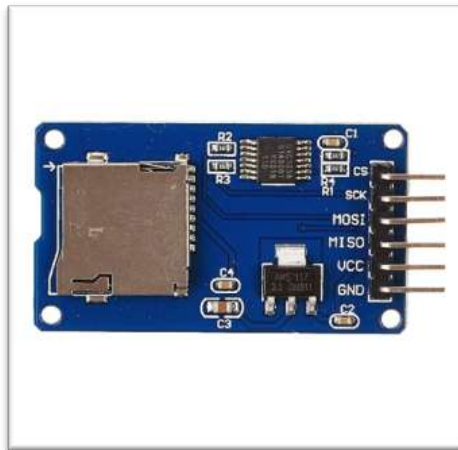

Figure 2.5.1.6 SD Card

**2.5.1.7 HC-05:** HC-05 is the Bluetooth module that is used to transmit the information from the model to our smartphones via Bluetooth. This sensor is present on the receiver module of the model.

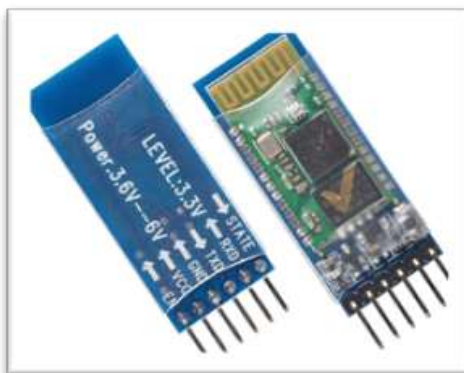

Figure 2.5.1.7 HC-05 Sensor

**2.5.1.8 RTC clock module:** RTC is a real-time clock that is used to keep a track of the exact date & time of the day. RTC clock module is integrated with all the sensor values which will record at what time and date the values are measured.



Figure 2.5.1.8 RTC Clock Module

## 2.5.2 SOFTWARE REQUIREMENTS:

Software Requirements specifies the logical characteristics of each interface and software components of the system. The following are some software requirements:

- IDE: Arduino IDE
- Languages: Embedded C, CPP

# **3. ARCHITECTURE**

### 3. ARCHITECTURE

#### 3.1 PROJECT ARCHITECTURE

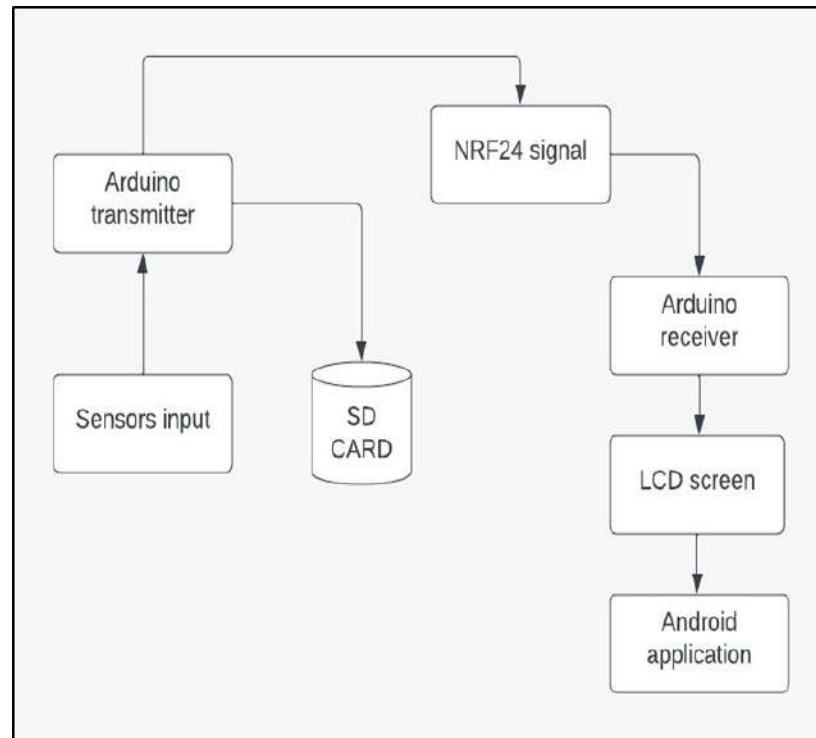

Figure 3.1 Project Architecture of Radiosonde Payload for Weather Monitoring System

#### 3.2 DESCRIPTION

The project is based on measuring the atmospheric weather conditions like temperature, pressure, humidity and air quality in a particular location or a place. The complete device implementing this project is made with the interaction between the payload and the receiver. The payload also known as the transmitter is attached to a balloon which collects the information from various sensors connected to an arduino. The payload with the balloon can be placed ranging from 50 mts to 1 km from the receiver for the model to work effectively.

### 3.3 USE CASE DIAGRAM

In the use case diagram, we have three actors who are the transmitter, the receiver and the application. A use case diagram shows various use cases and different types of users the system has. The use cases are represented by either circles or ellipses. The actors are often shown as stick figures. The purpose of use case diagram is to capture the dynamic aspect of a system.

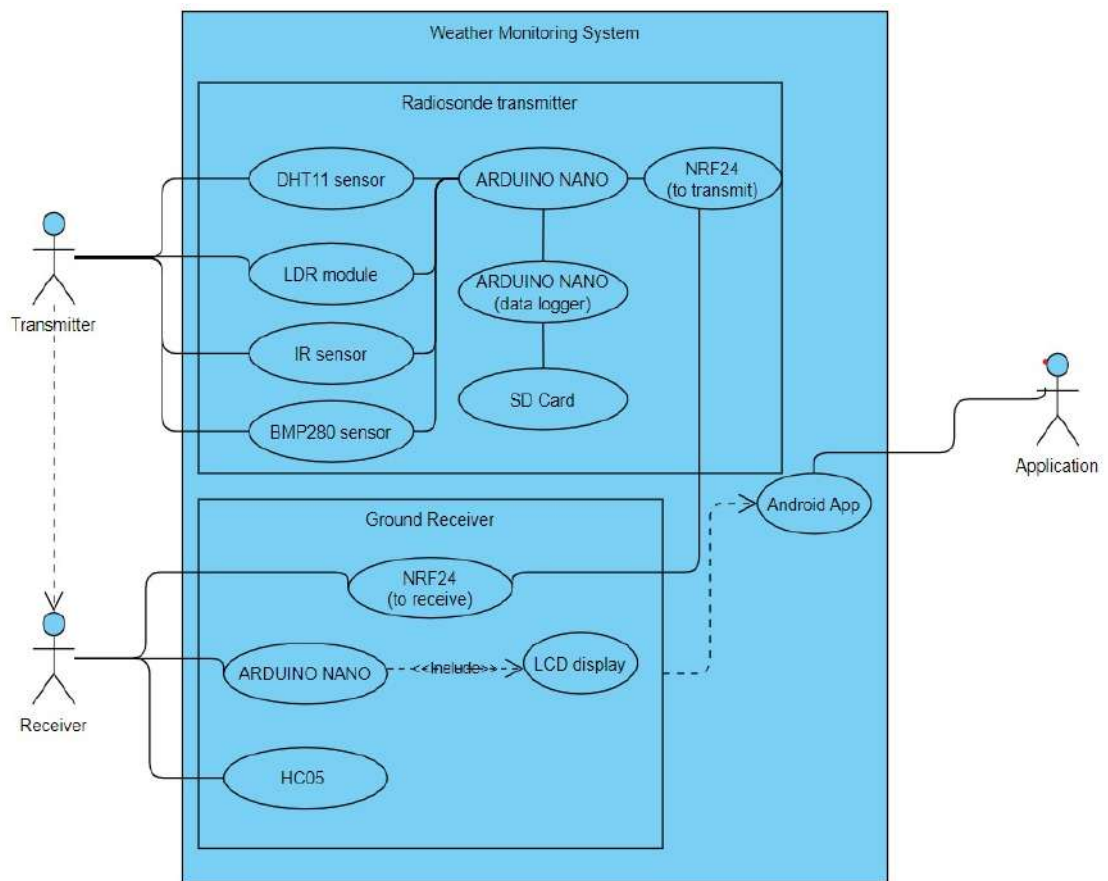

Figure 3.2 Use Case Diagram for Radiosonde Payload for Weather Monitoring System



### 3.4 CLASS DIAGRAM

Class Diagram is a collection of classes and objects. Class diagram describes the attributes and operations of a class and also the constraints imposed on the system. A Class diagram shows a collection of classes, interfaces, associations, collaborations, and constraints. Class diagrams are the only diagrams which can be directly mapped with object-oriented languages and thus widely used at the time of construction.

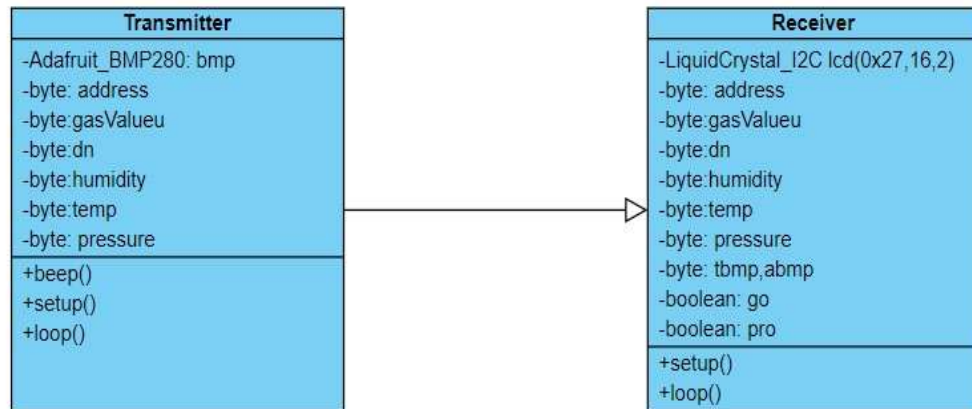

Figure 3.3 Class Diagram for Radiosonde Payload for Weather Monitoring System

### 3.5 SEQUENCE DIAGRAM

The sequence diagram is used primarily to show the interactions between objects in the sequential order that those interactions occur. Sequence diagrams describe how and in what order the objects in a system function. Sequence diagrams are sometimes called event diagrams or event scenarios. Sequence diagram emphasizes on time sequence of messages.

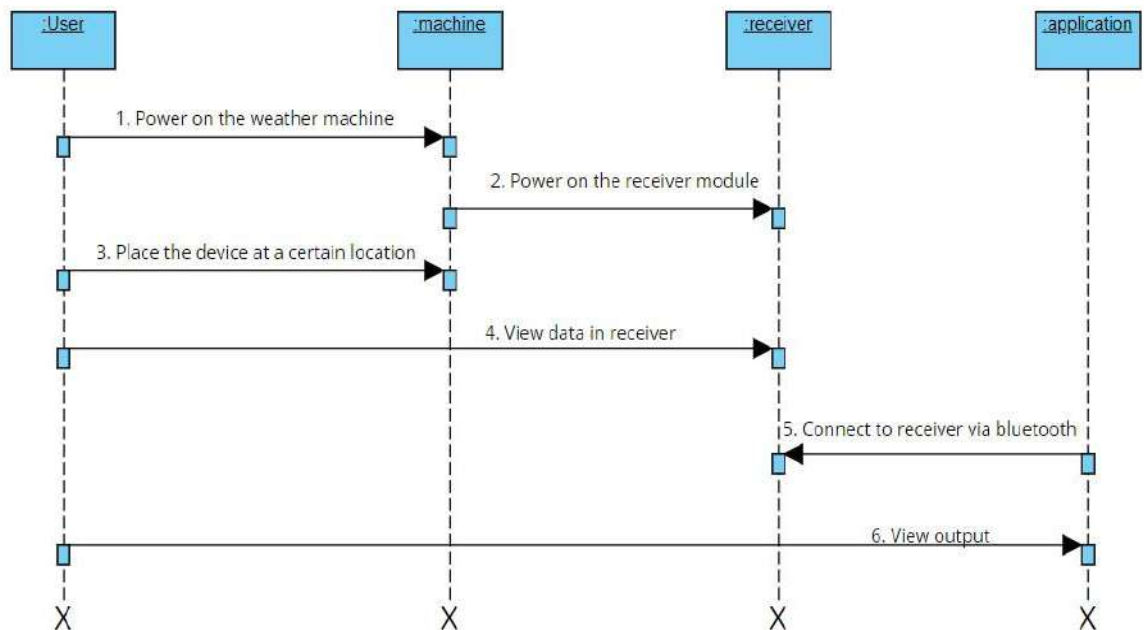

Figure 3.4 Sequence Diagram for Radiosonde Payload for Weather Monitoring System

### 3.6 ACTIVITY DIAGRAM

The activity diagram describes the flow of activity states. It is basically a flowchart to represent the flow from one activity to another activity. The activity can be described as an operation of the system. The control flow is drawn from one operation to another. This flow can be sequential, branched, or concurrent. Activity diagrams deal with all type of flow control by using different elements such as fork, join, etc.

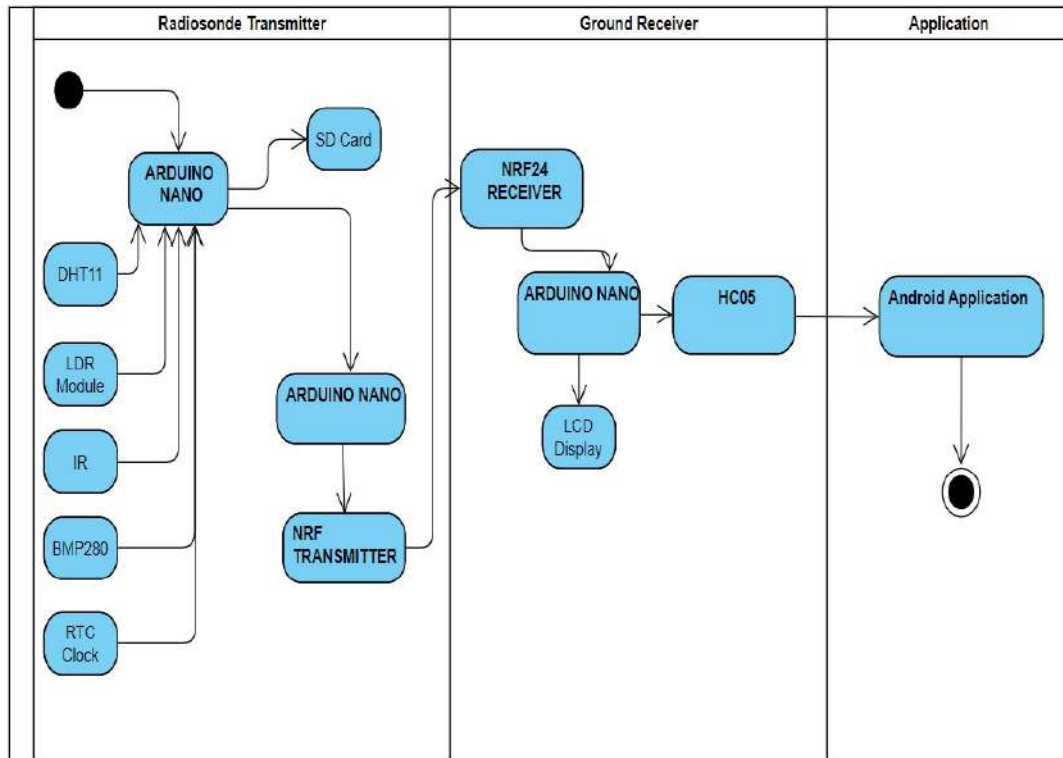

Figure 3.5 Activity Diagram for Radiosonde Payload for Weather Monitoring System

### 3.7 DATA FLOW DIAGRAM

A data-flow diagram is a way of representing a flow of data through a process or a system. It uses defined symbols like rectangles, circles and arrows, plus short text labels, to show data inputs, outputs, storage points and the routes between each destination. The DFD also provides information about the outputs and inputs of each entity and the process itself.

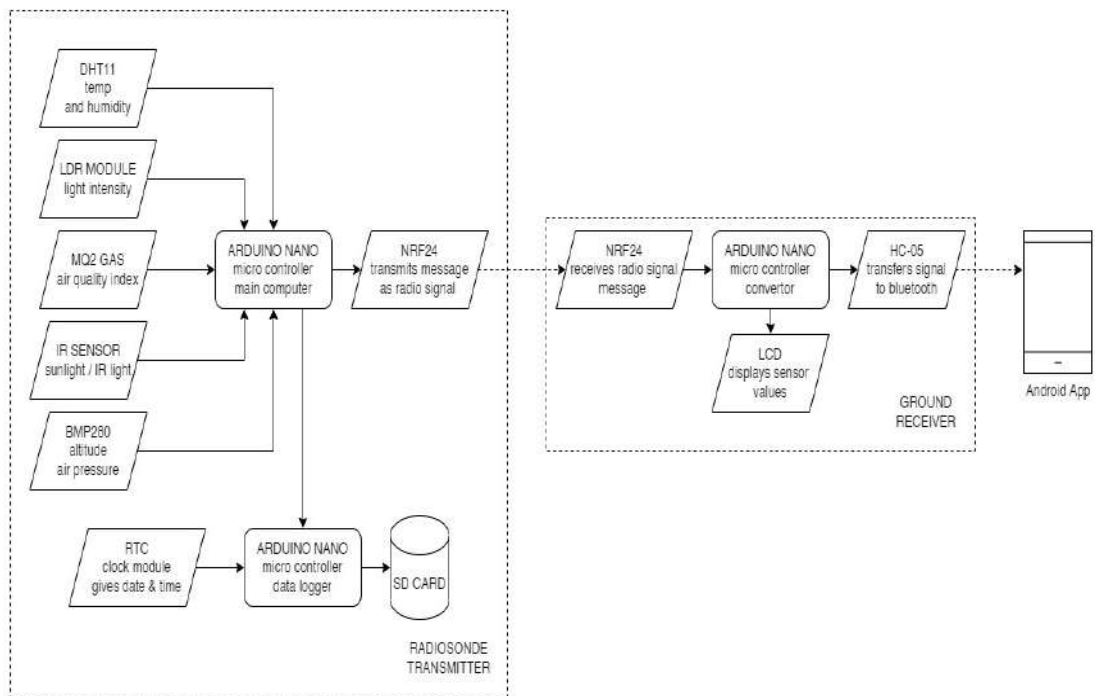

Figure 3.6 Data Flow Diagram for Radiosonde Payload for Weather Monitoring System

## **4. IMPLEMENTATION**

## 4.1 SAMPLE CODE

### Transmitter:

```

#include "DHT.h"
#include <Adafruit_BMP280.h>
#include <SPI.h>
#include <nRF24L01.h>
#include <RF24.h>
#define DHTTYPE DHT11
#define DHTPIN 7
#define gasPin A3
#define batPin A2
#define lightPin A1
#define buzzer 6
DHT dht(DHTPIN, DHTTYPE);
Adafruit_BMP280 bmp;
RF24 radio(9, 10);
const byte address[6] = "00001";
void beep(){
  tone(buzzer,1000);
  delay(250);
  noTone(buzzer);
  delay(250);
}
struct MyData {
  byte gasValue;
  byte dn;
  byte tbmp;
  byte pbmp;
  byte abmp;
  byte h;
  byte t;
  byte b;
};
MyData data;
void setup() {
  dht.begin();
  bmp.begin();
  bmp.setSampling(Adafruit_BMP280::MODE_NORMAL, /* Operating Mode. */
    Adafruit_BMP280::SAMPLING_X2, /* Temp. oversampling */
    Adafruit_BMP280::SAMPLING_X16, /* Pressure oversampling */
    Adafruit_BMP280::FILTER_X16, /* Filtering. */
    Adafruit_BMP280::STANDBY_MS_500); /* Standby time. */
  radio.begin();
  radio.openWritingPipe(address);
  radio.setPALevel(RF24_PA_MIN);
  radio.stopListening();

```

```

pinMode(6,OUTPUT);
Serial.begin(9600);
beep();
beep();
beep();
beep();
beep();
}
void loop() {
  data.gasValue = analogRead(gasPin);
  data.h = dht.readHumidity();
  data.t = dht.readTemperature();
  data.tbmp = bmp.readTemperature();
  data.pbmp = bmp.readPressure();
  data.abmp = bmp.readAltitude(1019.66);
  data.dn = map(analogRead(lightPin),0,1000,0,100); //LDR
  data.b = map(analogRead(batPin),125,155,0,100); // BATTERY
  radio.write(&data,sizeof(MyData)); // sent to reciever
  String text
=String(data.h)+"|"+String((data.t+data.tbmp)/2)+"|"+String(data.gasValue)+"|"+String
(data.pbmp)+"|"+String(data.abmp)+"|"+String(data.dn)+"|"+String(data.b);
  Serial.println(text);
  beep();
  delay(2500);
}

```

**Receiver:**

```

#include <SPI.h>
#include <nRF24L01.h>
#include <RF24.h>
#include <Wire.h>
#include <LiquidCrystal_I2C.h>
LiquidCrystal_I2C lcd(0x27, 16, 2);
RF24 radio(9, 10); // CE, CSN
bool pro=false;
bool go=false;
int n=0;
const byte address[6] = "00001";
struct MyData {
  byte gasValue;
  byte dn;
  byte tbmp;
  byte pbmp;
  byte abmp;
  byte h;
  byte t;
  byte b;

```

```

};
MyData data;
void setup() {
  Serial.begin(9600);           //Serial baud rate set to 9600
  radio.begin();               // nrf24
  radio.openReadingPipe(0, address);
  radio.setPALevel(RF24_PA_MIN);
  radio.startListening();
  lcd.begin();
  lcd.backlight();
  lcd.clear();
  lcd.setCursor(0,0);
  lcd.print("WELCOME");
  lcd.setCursor(0,1);
  lcd.print("WAITING...");
  Serial.println("WAITING");
  pinMode(3,INPUT_PULLUP);
}

void loop() {
  if ( radio.available() ) {
    pro=true;
    radio.read(&data, sizeof(MyData));
    Serial.println(data.h);
    Serial.println(data.t);
    Serial.println(data.dn);
    Serial.println(data.gasValue);
    Serial.println(data.tbmp);
    Serial.println(data.pbmp);
    Serial.println(data.abmp);
    Serial.println(data.b);
  }
  if(pro)
  {
    if(digitalRead(3)==LOW)
    {n=n+1;delay(500);go=true;}
    if(n==8)
    n=1;
    if(go)
    {
      Serial.println(n);
      switch(n){
        case 1:
          {lcd.clear();
            lcd.setCursor(0,0);
            lcd.print("HUMIDITY : ");
            lcd.setCursor(0,1);

```



```

lcd.print(data.h);
  lcd.print("%");}
  break;
  case 2:
  {lcd.clear();
  lcd.setCursor(0,0);
  lcd.print("TEMPERATURE : ");
  lcd.setCursor(0,1);
  lcd.print((data.t+data.tbmp)/2);
  lcd.print(" C");}
  break;
  case 3:
  {lcd.clear();
  lcd.setCursor(0,0);
  lcd.print("PRESSURE : ");
  lcd.setCursor(0,1);
  lcd.print(data.pbmp);
  lcd.print("kPa");}
  break;
  case 4:
  {lcd.clear();
  lcd.setCursor(0,0);
  lcd.print("ALTITUDE : ");
  lcd.setCursor(0,1);
  lcd.print(data.h);
  lcd.print("M ABV SEA LVL");}
  break;
  case 5:
  {lcd.clear();
  lcd.setCursor(0,0);
  lcd.print("BATTERY : ");
  lcd.setCursor(0,1);
  lcd.print(data.b);
  lcd.print("%");}
  break;
  case 6:
  {lcd.clear();
  lcd.setCursor(0,0);
  if(data.dn==1)
  lcd.print("DAY");
  if(data.dn==0)
  lcd.print("NIGHT");}
  break;
  case 7:
  {lcd.clear();
  lcd.setCursor(0,0);
  if(data.gasValue<50)

```

```

lcd.print("AIR : GOOD");
  if(data.gasValue>50)
    lcd.print("AIR : BAD") ;}
  break;
}
go=false;
}
}
}

```

### **SD card:**

```

#include <Wire.h> //i2c comm
#include <TimeLib.h> //clock
#include <SPI.h> // memory card
#include <SD.h> // sd card
#include <DS1307RTC.h> //clock
String data;
String info;
const int chipSelect = 10;
void setup() {
  Serial.begin(9600);
  SD.begin(chipSelect);
}
void loop() {
  delay(3000);
  File dataFile = SD.open("datalog.txt", FILE_WRITE);
  if(Serial.available())
  info=Serial.readString(); // read data from primary arduino
  else
  info="no data";
  tmElements_t tm;
  if (RTC.read(tm)) {
    int hr=tm.Hour;
    int mi=tm.Minute;
    int se=tm.Second;
    int da=tm.Day;
    int mo=tm.Month;
    int ye=tm.YearToCalendar(tm.Year);
    data=String(hr)+":"+String(mi)+":"+String(se)+"\t"+String(da)+":"+String(mo)+":"+String(ye)+"\t"+info;
  }
  else{
    data="Sensor not found";
  }
  dataFile.close();
}
}

```

## **5. SCREENSHOTS**

## 5.1 PAYLOAD EQUIPMENT

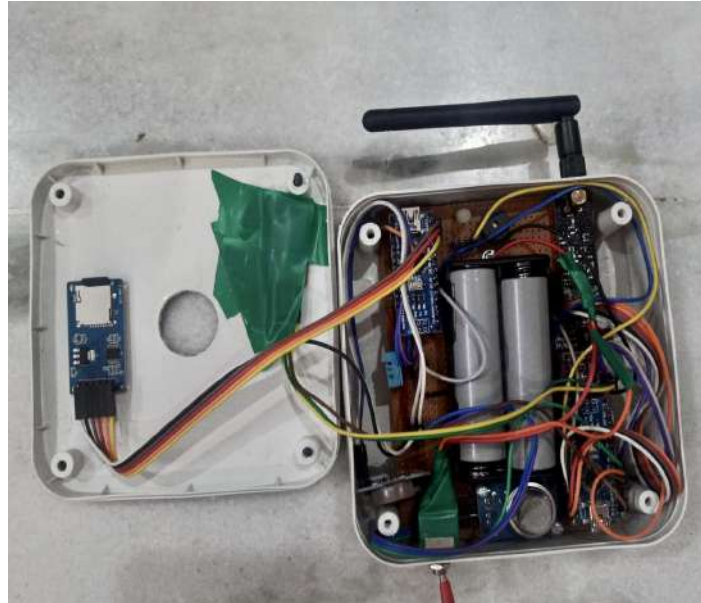

Screenshot 5.1.1 Transmitter

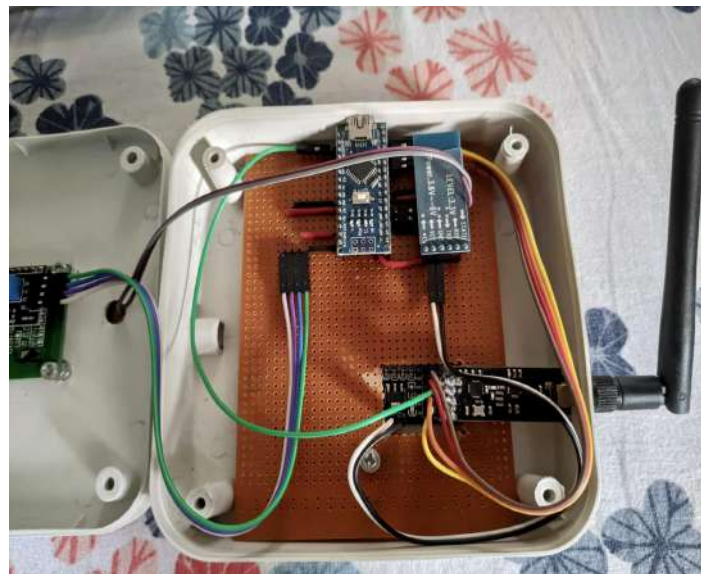

Screenshot 5.1.2 Receiver

## 5.2 Values Obtained

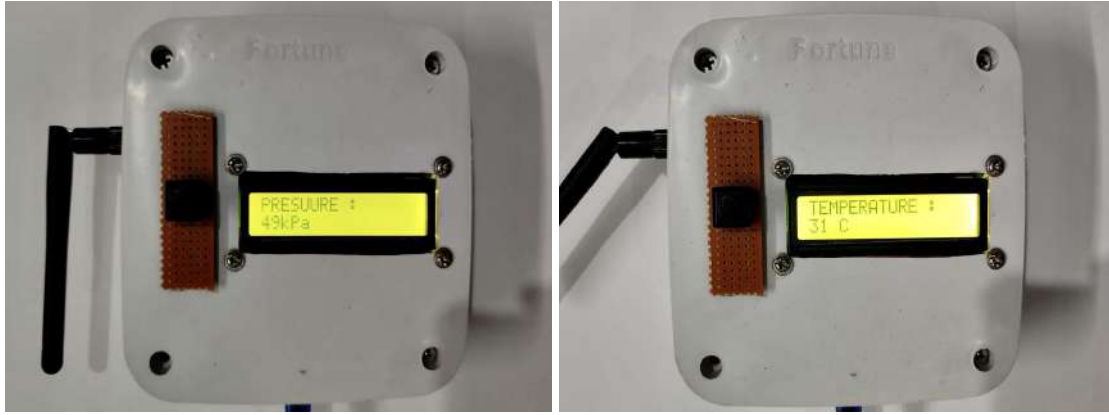

Screenshot 5.2.1 Display Values for Pressure and Temperature on LCD

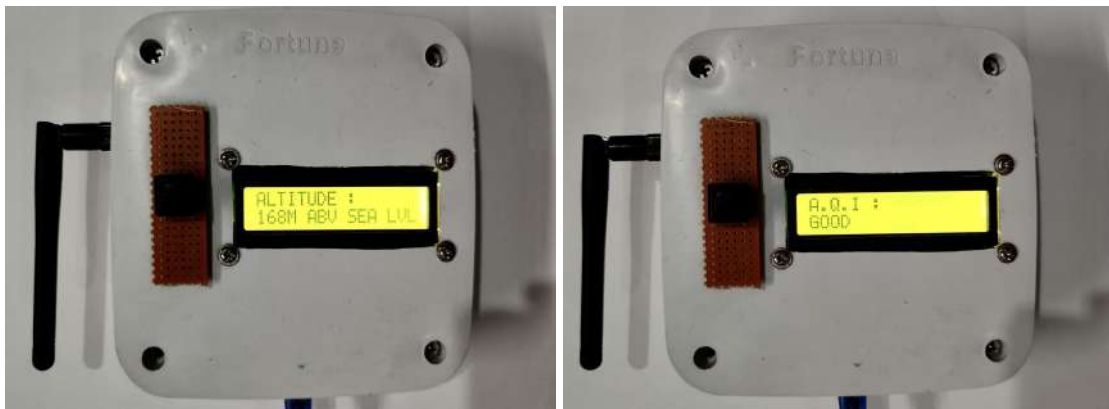

Screenshot 5.2.2 Display Values for Altitude and Air-Quality on LCD



Screenshot 5.2.3 Display Value of Battery level on LCD

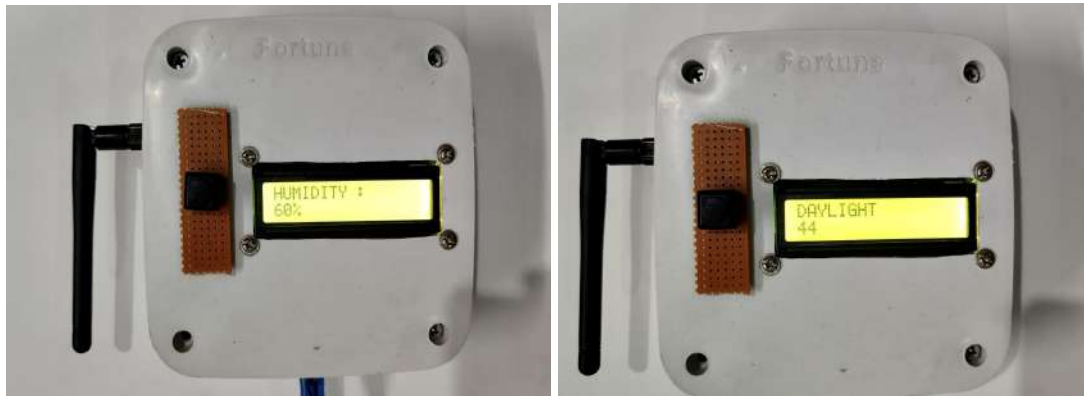

Screenshot 5.2.4 Display Values for Humidity and Daylight on LCD

### 5.3 Application view

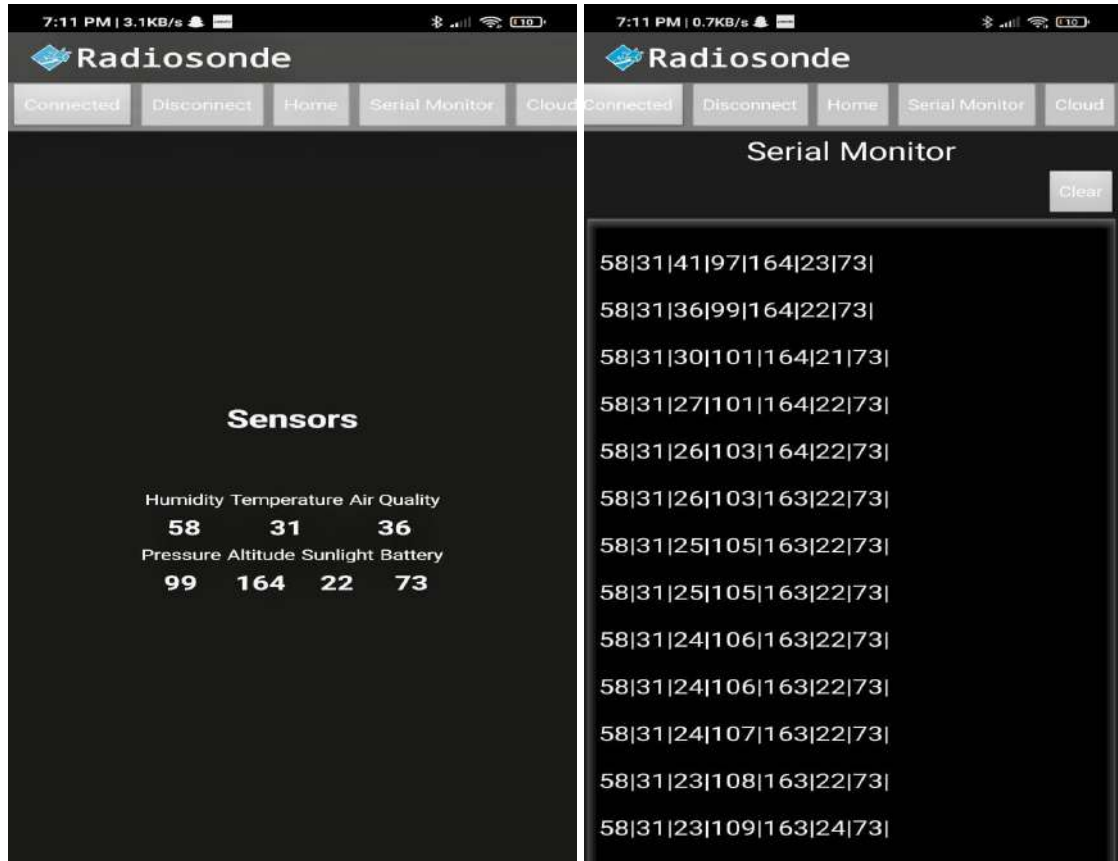

Screenshot 5.3 Application View of Sensors Value and Serial Monitor

## 5.4 SD Card Results

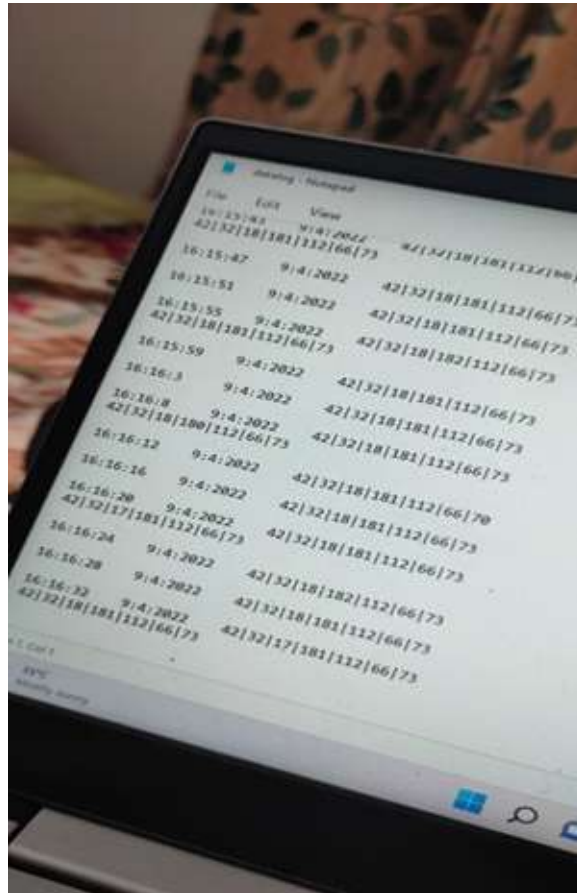

Screenshot 5.4 Results Stored on SD Card



# **6. TESTING**

## **6. TESTING**

### **6.1 INTRODUCTION TO TESTING**

The purpose of testing is to discover errors. Testing is the process of trying to discover every conceivable fault or weakness in a work product. It is the process of exercising software with the intent of ensuring that the Software system meets its requirements and user expectations and does not fail in an unacceptable manner.

### **6.2 TYPES OF TESTING**

#### **6.2.1 UNIT TESTING**

Unit testing involves the design of test cases that validate that the internal program logic is functioning properly, and that program inputs produce valid outputs. All decision branches and internal code flow should be validated. It is the testing of individual software units of the application. This is a structural testing that relies on knowledge of its construction and is invasive.

#### **6.2.2 INTEGRATION TESTING**

Integration tests are designed to test integrated software components to determine if they actually run as one program. Integration tests demonstrate that although the components were individually satisfactory, as shown by successfully unit testing, the combination of components is correct and consistent. Integration testing is specifically aimed at exposing the problems that arise from the combination of components.

#### **6.2.3 FUNCTIONAL TESTING**

Functional tests provide systematic demonstrations that functions tested are available as specified by the business and technical requirements, system documentation, . Functional testing is centered on the following items:

Valid Input : identified classes of valid input must be accepted

Invalid Input: identified classes of invalid input must be rejected.

Functions: identified functions must be exercised.

Output: identified classes of application outputs must be exercised.

Systems/Procedures: interfacing systems or procedures must be invoked.

### 6.3 TEST CASES

#### 6.3.1 WORKING OF PAYLOAD

SNO	Weather parameters	Values are taken indoors	Values are taken outdoors	Recorded values from high altitude	Recorded values from low altitude (Ground level)
1	Temperature	30 (C)	31 (C)	34 (C)	32 (C)
2	Humidity	69%	68 %	64 %	56 %
3	pressure	102 (kPa)	96 (kPa)	39 kPa	124 kPa
4	Altitude	141 m	142 m	147 m	139 m
5	Daylight	30 %	95 %	97%	91 %
6	Air quality	16ppm)	17 ppm	Good	good

Table 6.1 Values taken from different testcases

## **7. CONCLUSION**

## **7. CONCLUSION & FUTURE SCOPE**

### **7.1 PROJECT CONCLUSION**

The model is an ongoing prototype embedded system that is developed with the notion to have a cost-effective, reliable, and simple model which is having the ability to produce accurate atmospheric weather parameters. Further enhancements in the model can be possible with much stronger batteries and sensors and can be upgraded with wi-fi-enabled cloud communication. With much farther communication enhancement between the payload and ground station implementation on a wider radius of the area is possible which is a potential future enhancement.

### **7.2 Future Scope**

The potential idea behind the development of the project was to develop a system that can measure atmospheric weather conditions effectively. The future enhancement would be to convert the prototype model into a real-time embedded system that can be implemented within a large radius. The usage of greater quality sensors with high-capacity batteries to run on a large scale. Another enhancement would be multiple transmitters present at different locations with a single receiver to collect all the information from these various locations and for the comparison of various atmospheric parameters for long-term trend analysis.

## **8. BIBLIOGRAPHY**

## 8. BIBLIOGRAPHY

### 8.1 REFERENCES

[1] Mr. Mohit Tiwari, Deepak Narang, Priya Goel, Anupama Gadhwal, Abhinav Gupta, and Ankush Chawla, "WEATHER MONITORING SYSTEM USING IOT AND CLOUD COMPUTING", International Journal of Advanced Science and Technology.

[2] Shubham Wankhede, Anushri Kher, Komal Rawate, Mrs. M.A. Kango, "RADIOSONDE PAYLOAD FOR WEATHER BALLOONS", International Research Journal of Engineering and Technology (IRJET), Volume: 05 Issue: 03 | Mar-2018.

[3] Ferdin Joe John Joseph, "IoT Based Weather Monitoring System for Effective Analytics", International Journal of Engineering and Advanced Technology (IJEAT) ISSN: 2249 – 8958, Volume-8 Issue-4, April 2019.

[4] Snehal R. Shinde, A. H. Karode, Dr. S. R. Suralkar, "REVIEW ON - IOT BASED ENVIRONMENT MONITORING SYSTEM", International Journal of Electronics and Communication Engineering and Technology (IJECE) Volume 8, Issue 2, March - April 2017.

[5] S. Zafar, G. Miraj, R. Baloch, D. Murtaza, and K. Arshad, "An IoT Based Real-Time Environmental Monitoring System Using Arduino and Cloud Service", Eng. Technol. Appl. Sci. Res., vol. 8, no. 4, pp. 3238-3242, Aug. 2018.

[6] "Arduino." [Online]. Available: <http://www.arduino.cc/download>

[7] R Suresh Babu, T Palaniappan, K. Anushya, M Kowsalya, M Krishnadevi, "IoT Based Weather Monitoring System", International Journal of Advanced Research Trends in Engineering and Technology (IJARTET) Vol. 5, Special Issue 13, March 2018.

### 8.2 GITHUB LINK

<https://github.com/sravya666/MAJOR-PROJECT>

# Radiosonde Payload for Weather Monitoring Systems

<sup>1</sup>Jonnadula Narasimharao, <sup>2</sup>CH. Lakshmi Sravya, <sup>3</sup>Sathu Tharun, <sup>4</sup>Parasa Rithvik

<sup>1</sup>Associate Professor of Dept of CSE, CMR Technical Campus, Hyderabad, India

<sup>2,3,4</sup>UG Student, CMR Technical Campus, Dept of CSE, Hyderabad, India

**Abstract:-** The system aims to design a reliable embedded system that will be used in measuring various atmospheric parameters for up-to-date weather monitoring. Weather is monitored with the help of payload equipment which acts as a transmitter in which temperature, pressure, humidity, altitude, air quality, and light detection is measured with the combined action of all the sensors. These measured values are then transmitted to the ground receiver to view the information from the various sensors. NRF frequency signals are used for the communication between transmitter and receiver respectively. All the sensors and the transmitter/receiver module would be connected to the main Arduino/Microcontroller. The data received would be continuous and can be viewed from time to time on the receiver module, smartphones, and cloud storage simultaneously. The project is developed to produce a weather monitoring device capable to measure with more accuracy, reliability, and cost-efficiency.

**Keywords:-** Arduino; sensors; cloud; transmitter; receiver; wireless communication.

## I. INTRODUCTION

Weather monitoring has always been a crucial part of detecting and recording various atmospheric parameters from various locations, and places, and comparing the various known values. Temperature, barometric pressure, altitude, light detection, air quality index, and humidity can be easily known from the present weather monitoring sensors and various types of equipment. Using IoT to effectively collect the various information from different kinds of weather monitoring sensors and store them either in SD cards or cloud storage. The collective work of all the sensors is the result of the values that we can see today. Arduino nano, the microcontroller is responsible for connecting multiple devices and exchanging real-time data using a simple interface. The Arduino is coded to collect information from these multiple devices to either display the information or store it in the cloud. Apart from using the sensors and Arduino, an SD/memory card is used to collect the information from the devices to secure it in times when there is any communication failure. The model runs in two parts one is the transmitter and the other is the receiver. The wireless communication between the two parts takes place with the help of NRF24 signals in the probable range from 50mts to 1km. Using the Bluetooth module, the information can be transmitted to our smartphone and can be viewed on the application. Cloud storage is an effective way to store the information on the internet and for easy access and retrieval of the data. This helps us to use this data for a long

time and can also be used for trend analysis of the climatic conditions, graphical representations, and monitoring the weather conditions and thereby sending alerts, and notifications regarding the various parameters of the weather.

## II. LITERATURE SURVEY

The usage of IoT devices has played a major role in the weather monitoring system. A wide range of applications to the existing weather monitoring system has been developed using IoT sensors and devices. Devices like Arduino, Raspberry Pi, Node MCU, etc are being used as the main components in the development of weather monitoring systems. Using Raspberry Pi to implement the weather monitoring system is exclusively discussed in [3] where Raspberry Pi is interfaced with the sensors in determining the atmospheric weather parameters. Using of cloud storage or a local web server [3] has become a medium to store the information for long-term usage. How an Arduino in the weather monitoring system is operated and enabled with a Wi-Fi module [1] is shown which explains how conveniently the usage of the sensors to obtain information and using the Wi-Fi module to establish the connection between the microcontrollers. Communication between the microcontrollers and sensors can be possible with either Bluetooth, Wi-Fi, NFC, etc [4]. In [4] the various modes of communication and the comparison between different modes have been discussed and from that Bluetooth has been selected as the preferred mode of communication in our project. Various sensors like DHT11 [1-5], BMP280 [1], etc are some of the most used sensors that are used to measure the temperature, barometric pressure, and humidity, and a majority of weather monitoring systems applications use these sensors as the main parts in their development. How a transmitter and receiver which are the two main parts of any weather monitoring system works is clearly explained in [2] which describes the actions performed by the transmitter as well as the receiver. Another model which shows the monitoring of weather uses the Nodemcu [6] to implement the weather monitoring system. The soil is measured at various locations and the sensors are placed at various locations and the collective information from all the sensors is collected to a local web browser using Thing speak [6]. By this way of using the sensors at various places, the information from various locations can be known simultaneously



### III. PROPOSED METHODOLOGY

We propose a system that is used to measure, monitor, record, and control various atmospheric weather parameters like temperature, pressure, humidity, air quality, sunlight, and altitude. This can be implemented by using several sensors like DHT11, BMP280, LDR Module, IR sensor, HC-05, MQ2 Gas sensor, and RTC Module. The model is implemented in two parts i.e., the transmitter and receiver. The transmitter or the payload has the combination of all these sensors that are connected to the main microcontroller which is the Arduino. The transmitter also has the SD/memory card that is connected to another Arduino for storing the information. The transmitter module is also connected to the primary Arduino. In the receiver end, we have the receiver module and the Bluetooth sensors that are connected to another Arduino nano. The information from the transmitter is received on to the receiver which is displayed on the LCD screen. The model operates with two 3.6volts batteries which produce the main power. As the power is switched on it gives 5 beeps to indicate that the model is on and the sensing of the values will start soon. All the values are displayed on the LCD screen on the receiver with a gap of 3 seconds. We can place the transmitter wherever we wish to in a radius of 10mts to 1km and keep the receiver module with us to monitor and view the weather parameters. Simultaneously the information is stored on the SD card as well and the information can be viewed on the computer screen as well (shown in Fig.1)

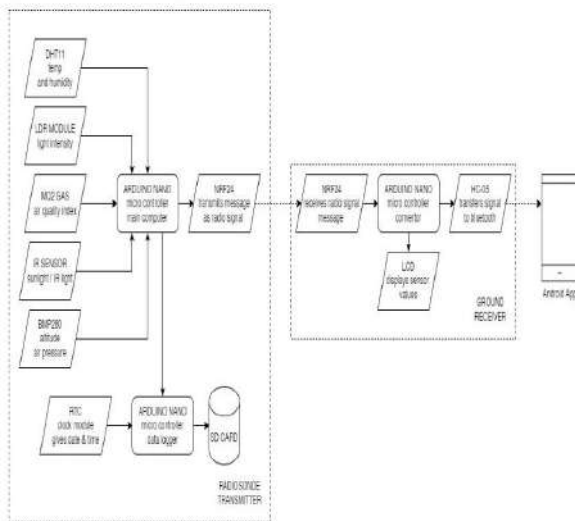

Fig. 1: Overview of the weather monitoring system

#### A. Required Components

##### a) ARDUINO NANO:

Arduino nano is also the microcontroller through which all the connections are made and sensors are connected. Arduino IDE is used to communicate with the sensor's actions and has 14 pins in total and operates at 5volts. In the developed model, three

microcontrollers are used for transmitter and receiver connections.

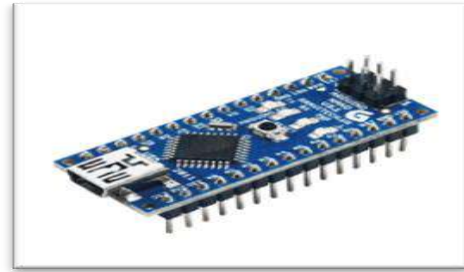

Fig. 2: Arduino nano

##### b) BMP280:

The real-time temperature and air pressure can be known with a BMP280 sensor. It uses a very low amount of power to operate effectively.

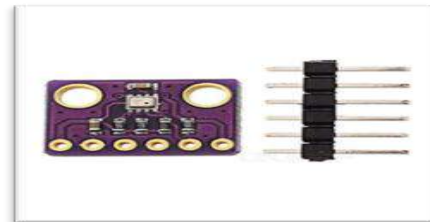

Fig. 3: BMP280

##### c) DHT11:

DHT11 is a temperature and humidity sensor. The sensor has a humidity measurement component and a temperature measurement component. High reliability, fast response, and cost-effectiveness can be seen with this sensor.

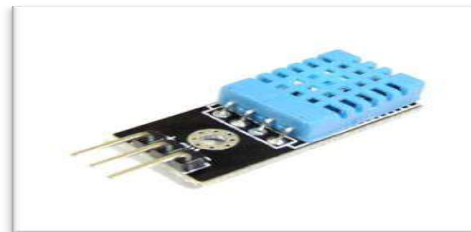

Fig. 4: DHT11

##### d) NRF24:

NRF24 signal is used for wireless communication between all the microcontrollers. Transmission of received data is provided by the RF transmitter, while the data is received by the RF receiver.



Fig. 5. NRF24

Fig. 8: HC-05

e) LDR MODULE:

To indicate the presence of daylight in particular surroundings LDR module is used. Depending upon the presence or absence of light the daylight is measured and displayed.



Fig. 6: LDR Module

f) SD CARD:

The memory card is used to store the information from the sensors that are present in the transmitter module. The SD card when connected to a personal computer the information can be viewed.

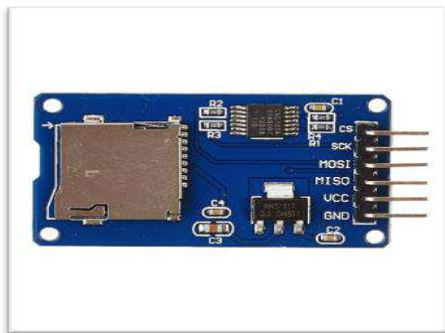
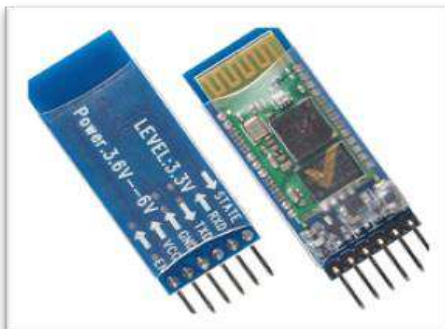

Fig. 7: SD Card

g) HC-05:

HC-05 is the Bluetooth module that is used to transmit the information from the model to our smartphones via Bluetooth. This sensor is present on the receiver module of the model.



h) RTC clock module:

RTC is a real-time clock that is used to keep a track of the exact date & time of the day. RTC clock module is integrated with all the sensor values which will record at what time and date the values are measured.

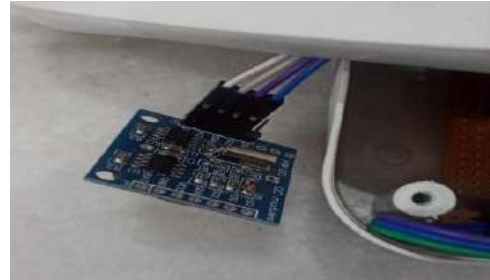

Fig. 9: RTC Clock Module

B. Connections

The model consists of a receiver and a transmitter which is discussed below. The transmitter or the payload (shown in Fig.11) contains the sensors and transmitter module connected to one Arduino, and the SD card connected to another Arduino. The RTC clock module is present to produce real-time data and time continuously. The receiver (shown in Fig.10), has the Bluetooth module and a receiver module that is connected to the Arduino. The battery present in the transmitter module is of 3.6volts and two batteries of 7.2volts are present. As Arduino can operate at a voltage of 5volts the voltage division from 7.2v to 5v takes place and power is provided. The mode of communication between the microcontrollers of both the parts takes place with the NRF24 signals and the values are displayed on the LCD screen which is discussed in the results. The Bluetooth module is the HC-5 sensor that is used for the transfer of data from the receiver to our smartphones.



Fig. 10: Receiver module



Fig. 11: Transmitter module

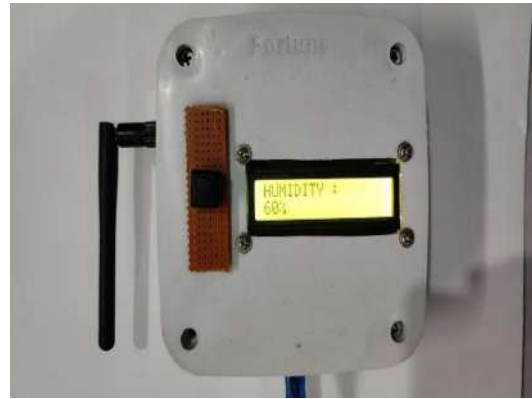

Fig. 15: Humidity displayed on LCD



Fig. 12: The overall view of the model



Fig. 16: Altitude displayed on LCD

#### IV. RESULTS



Fig. 13: Temperature displayed on LCD



Fig. 17: Battery percentage displayed on LCD



Fig. 14: Pressure displayed on LCD



Fig. 18: Air quality index result displayed on LCD



Fig. 19: The results on the serial monitor displayed on the smartphone

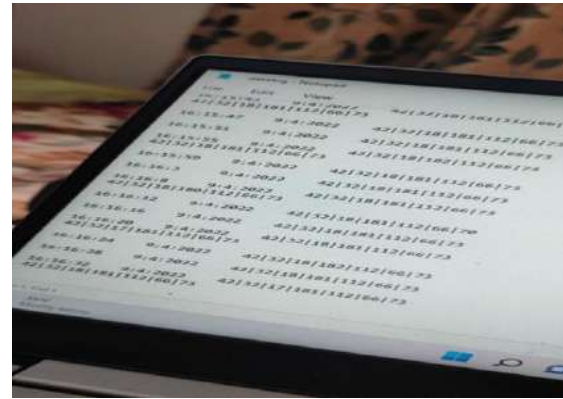

Fig. 20. The results stored on the SD card



Fig. 21: The value of daylight displayed on the LCD

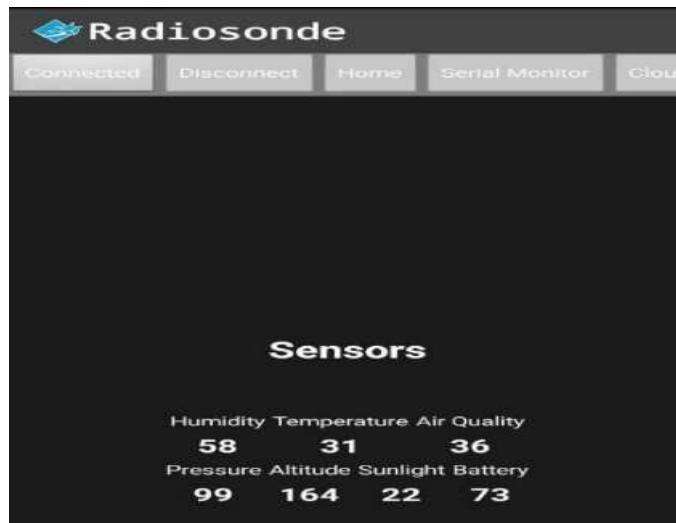

Fig. 22: The results of sensor values on the smartphone

**V. TABLES**

SNO	WEATHER PARAMETERS	SENSORS
1	Temperature	DHT11, BMP280
2	Humidity	DHT11
3	Pressure	BMP280
4	Air quality	MQ2 gas
5	Altitude	BMP280
6	Daylight	LDR

Table 1: The sensors used for the weather parameters



SNO	Weather parameters	Values are taken indoors	Values are taken outdoors	Recorded values from high altitude	Recorded values from low altitude (Ground level)
1	Temperature	30 (C)	31 (C)	34 (C)	32 (C)
2	Humidity	69%	68 %	64 %	56 %
3	pressure	102 (kPa)	96 (kPa)	39 kPa	124 kPa
4	Altitude	141 m	142 m	147 m	139 m
5	Daylight	30 %	95 %	97%	91 %
6	Air quality	16ppm)	17 ppm	Good	good

Table 2: Results in the analysis of the information from various sensors

## VI. CONCLUSION

The model is an ongoing prototype embedded system that is developed with the notion to have a cost-effective, reliable, and simple model which is having the ability to produce accurate atmospheric weather parameters. Further enhancements in the model can be possible with much stronger batteries and sensors and can be upgraded with wi-fi-enabled cloud communication. With much farther communication enhancement between the payload and ground station implementation on a wider radius of the area is possible which is a potential future enhancement.

## ACKNOWLEDGMENT

We thank CMR Technical Campus for supporting this paper titled with "RADIOSONDE PAYLOAD FOR WEATHER MONITORING SYSTEM", which provided good facilities and support to accomplish our work. We Sincerely thank our Chairman, Director, Deans, Guide, and faculty members for giving valuable suggestions and guidance in every aspect of our work.

## REFERENCES

- [1.] Mr. Mohit Tiwari, Deepak Narang, Priya Goel, Anupama Gadhwal, Abhinav Gupta, and Ankush Chawla, "WEATHER MONITORING SYSTEM USING IOT AND CLOUD COMPUTING", International Journal of Advanced Science and Technology
- [2.] Shubham Wankhede, Anushri Kher, Komal Rawate, Mrs. M.A. Kango, "RADIOSONDE PAYLOAD FOR WEATHER BALLOONS", International Research Journal of Engineering and Technology (IRJET), Volume: 05 Issue: 03 | Mar-2018
- [3.] Ferdin Joe John Joseph, "IoT Based Weather Monitoring System for Effective Analytics", International Journal of Engineering and Advanced Technology (IJEAT) ISSN: 2249 – 8958, Volume-8 Issue-4, April 2019.
- [4.] Snehal R. Shinde, A. H. Karode, Dr. S. R. Suralkar, "REVIEW ON - IOT BASED ENVIRONMENT MONITORING SYSTEM", International Journal of Electronics and Communication Engineering and Technology (IJECET) Volume 8, Issue 2, March - April 2017.
- [5.] S. Zafar, G. Miraj, R. Baloch, D. Murtaza, and K. Arshad, "An IoT Based Real-Time Environmental Monitoring System Using Arduino and Cloud

Service", Eng. Technol. Appl. Sci. Res., vol. 8, no. 4, pp. 3238-3242, Aug. 2018.

- [6.] R Suresh Babu, T Palaniappan, K. Anushya, M Kowsalya, M Krishnadevi, "IoT Based Weather Monitoring System", International Journal of Advanced Research Trends in Engineering and Technology (IJARTET) Vol. 5, Special Issue 13, March 2018.

# INTERNATIONAL JOURNAL OF INNOVATIVE SCIENCE AND RESEARCH TECHNOLOGY

IJISRT A DIGITAL LIBRARY

ISSN NO :- 2456-2165

## AUTHOR CERTIFICATE

THIS IS TO CERTIFY THAT THE MANUSCRIPT, ENTITLED  
Radiosonde Payload for Weather Monitoring Systems

AUTHORED BY  
CH. Lakshmi Sravya

HAS BEEN PUBLISHED IN  
Volume 7 | Issue 6 | June - 2022

ARTICLE DIGITAL NO.  
IJISRT22JUN235



EDITOR IN CHIEF IJISRT

This document certifies that the manuscript listed above was submitted by above said respected author  
To verify the submitted manuscript please visit our official website: [www.ijisrt.com](http://www.ijisrt.com)  
Or Email us: [editor@ijisrt.com](mailto:editor@ijisrt.com)

# INTERNATIONAL JOURNAL OF INNOVATIVE SCIENCE AND RESEARCH TECHNOLOGY

IJISRT A DIGITAL LIBRARY

ISSN NO :- 2456-2165

## AUTHOR CERTIFICATE

THIS IS TO CERTIFY THAT THE MANUSCRIPT, ENTITLED  
Radiosonde Payload for Weather Monitoring Systems

AUTHORED BY  
Sathu Tharun

HAS BEEN PUBLISHED IN  
Volume 7 | Issue 6 | June - 2022

ARTICLE DIGITAL NO.  
IJISRT22JUN235



EDITOR IN CHIEF IJISRT

This document certifies that the manuscript listed above was submitted by above said respected author  
To verify the submitted manuscript please visit our official website: [www.ijisrt.com](http://www.ijisrt.com)  
Or Email us: [editor@ijisrt.com](mailto:editor@ijisrt.com)



# INTERNATIONAL JOURNAL OF INNOVATIVE SCIENCE AND RESEARCH TECHNOLOGY

IJISRT A DIGITAL LIBRARY

ISSN NO :- 2456-2165

## AUTHOR CERTIFICATE

THIS IS TO CERTIFY THAT THE MANUSCRIPT, ENTITLED  
Radiosonde Payload for Weather Monitoring Systems

AUTHORED BY  
Parasa Rithvik

HAS BEEN PUBLISHED IN  
Volume 7 | Issue 6 | June - 2022

ARTICLE DIGITAL NO.  
IJISRT22JUN235



EDITOR IN CHIEF IJISRT

This document certifies that the manuscript listed above was submitted by above said respected author  
To verify the submitted manuscript please visit our official website: [www.ijisrt.com](http://www.ijisrt.com)  
Or Email us: [editor@ijisrt.com](mailto:editor@ijisrt.com)